

BIGTREETECH

Pi V1.2

User Manual

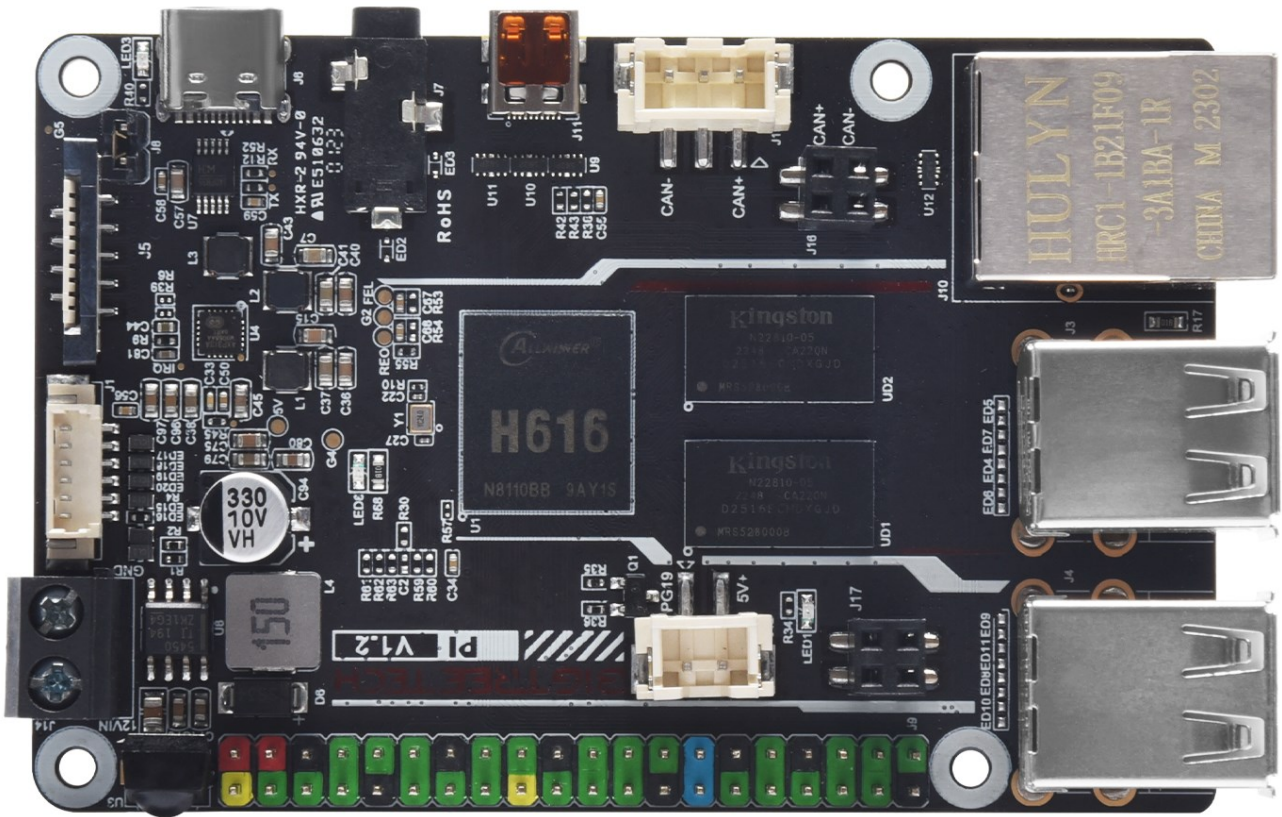

CONTENTS

Revision History	3
Product Profile	4
Feature Highlights	4
Specifications	4
Dimensions	5
Peripheral Port	5
Connector Diagram	5
Connection Description	6
Power Supply	6
40 pins GPIO	7
ADXL345 Wiring	7
SPI Display Wiring	8
Connecting a USB To CAN Module	9
Fan Wiring	9
HDMI Display Wiring	10
OS Writing	11
Download OS Image	11
Download and Install Writing Software	11
Start to Write OS	11
Using Raspberry Pi Imager	11
Using balenaEtcher	13
Network Configuration	15
Wired Network	15
WiFi Setting	15
Configure the Motherboard	16
SSH Connect to Device	16
Compile MCU Firmware	17
Cautions	19

Revision History

Version	Revisions	Date
01.00	Original	2022/12/29

Product Profile

BIGTREETECH Pi v1.2 has the same size and the same mounting hole location as Raspberry Pi, with 2.4GHz WiFi built in.

Feature Highlights

1. CPU: ALLWINNER H616, Quad-core Cortex-A53 @1.5GHz
2. GPU: Mali G31 MP2, Support OpenGL3.2
3. RAM: 1GB DDR3L SDRAM
4. Display: HDMI2.0A Port, 4K Supported
5. 4 x USB 2.0 Ports
6. Fast Ethernet + 100Mbps WiFi
7. Audio: 3.5mm Jack
8. 40-pin GPIO
9. Display: SPI Port
10. ADXL345 Port
11. Onboard connecting port for USB To CAN Module.
12. Built-in IR Receiver
13. The mounting holes are in the same location as Raspberry Pi.

Specifications

1. Product Dimensions: 85 x 56 mm
2. Mounting Size: 64 x 49.4 mm
3. Type-C Input Voltage: DC 5V±5%/2A
4. Input Voltage of Power IN Terminal: DC 12V-24V
5. Pi v1.2 Output Voltage: 3.3V±2%/100mA
6. Pi v1.2 WiFi: 2.4G/802.11 b/g/n Wireless LAN

Dimensions

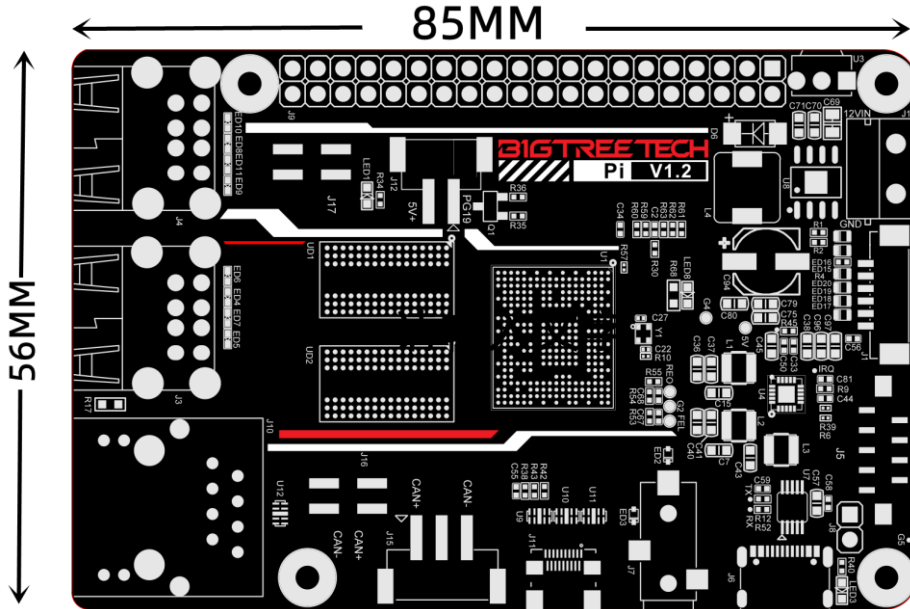

Peripheral Port
Connector Diagram

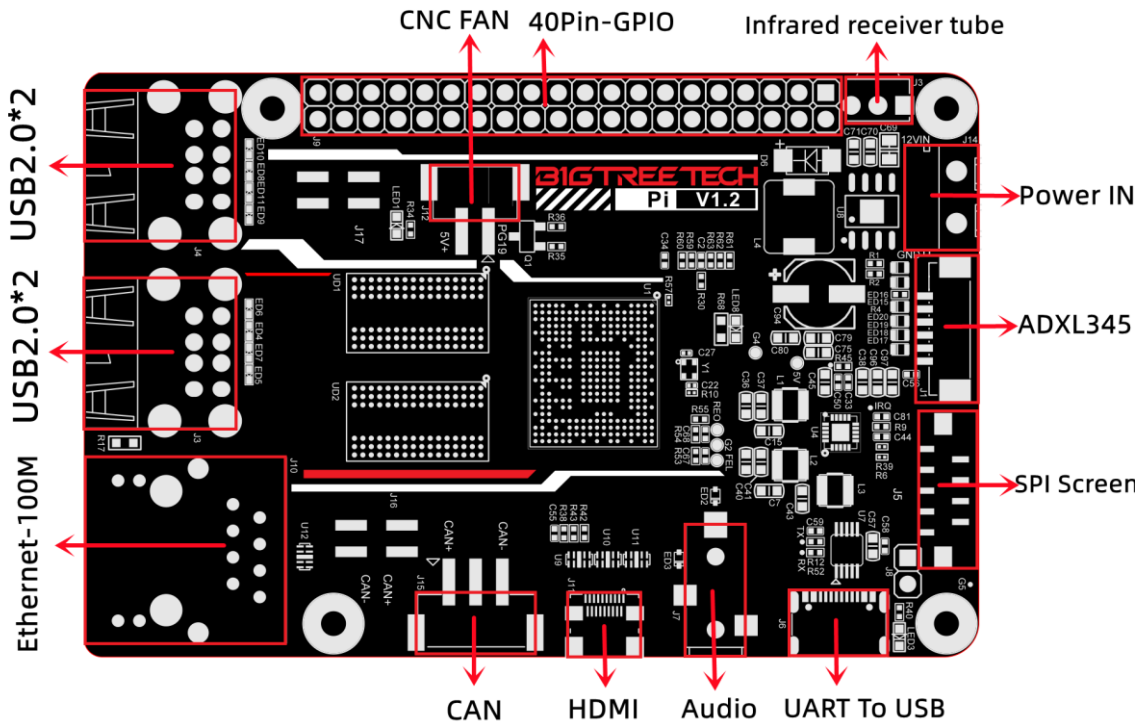

Connection Description

Power Supply

USB Power Supply: The SOC's UART converts USB signals through WCH340E. Connect this port to the PC to monitor Pi startup via the serial port tool, and identify faulty parts if there are any.

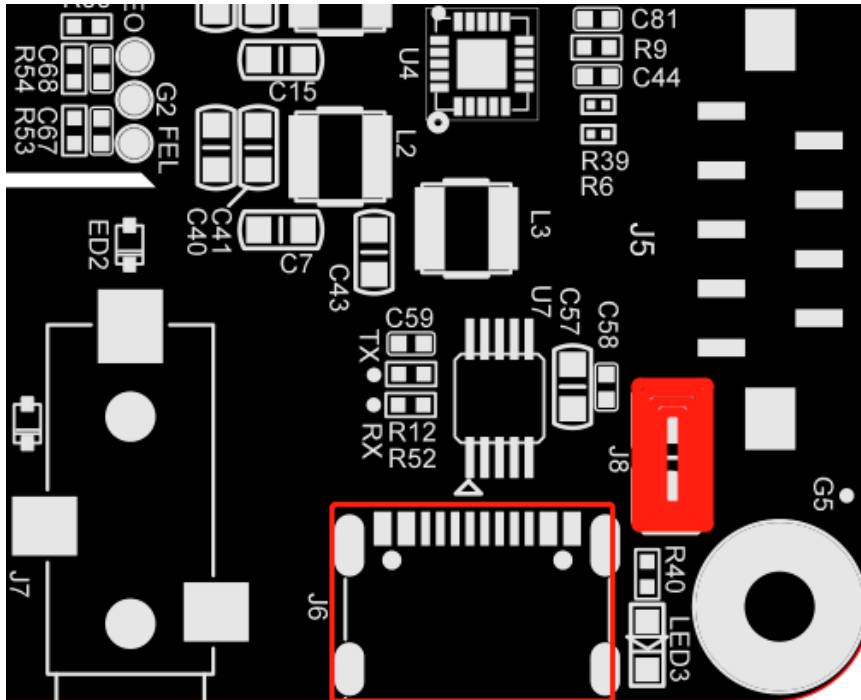

USB-C
5V IN

DC12-24V:

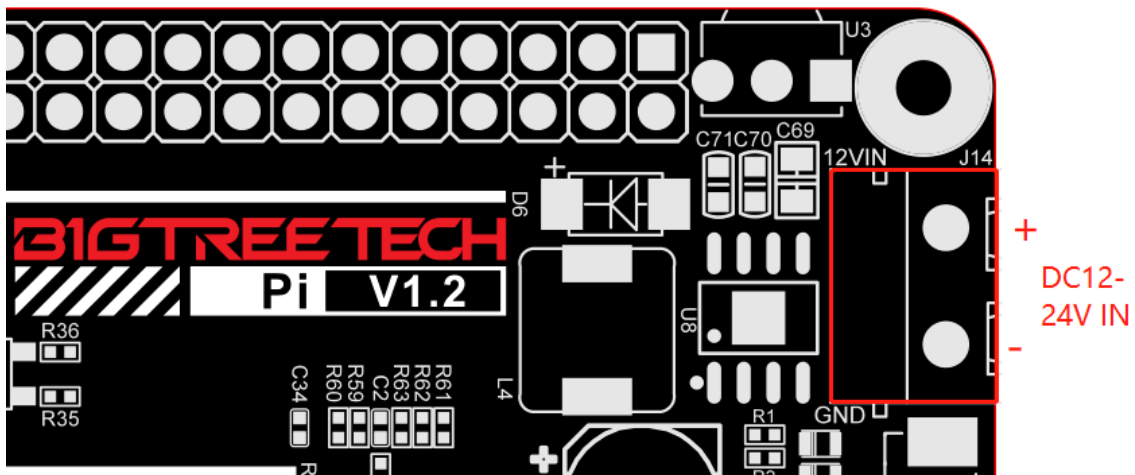

+
DC12-
24V IN
-

40 pins GPIO

40Pin-GPIO								
BTT Pi	CB1-eMMC	CB1	CM4		CM4	CB1	CB1-eMMC	BTT Pi
3.3V	3.3V	3.3V	3.3V		5V	5V	5V	5V
PC3	NC	NC	GPIO 2 (I2C1_SDA)		5V	5V	5V	5V
PC0	NC	NC	GPIO 3 (I2C1_SCL)		GND	GND	GND	GND
PC7	PI14	PC7	GPIO 4 (GPCLK0)		GPIO 14 (UART_TX)	TX	TX	TX
GND	GND	GND	GND		GPIO 15 (UART_RX)	RX	RX	RX
PC14	PI15	PC14	GPIO 17		GPIO 18 (PCM_CLK)	PC13	PI7	PC13
PC12	PI6	PC12	GPIO 27		GND	GND	GND	GND
PC10	PI4	PC10	GPIO 22		GPIO 23	PC11	PI5	PC11
3.3V	3.3V	3.3V	3.3V		GPIO 24	PC9	PI3	PC9
PH7	PH7	PH7	GPIO 10 (SPI0_MOSI)		GND	GND	GND	GND
PH8	PH8	PH8	GPIO 9 (SPI0_MISO)		GPIO 25	NC	NC	PG13
PH6	PH6	PH6	GPIO 11 (SPI0_SCLK)		GPIO 8 (SPI0_CE0)	NC	NC	PG12
GND	GND	GND	GND		GPIO 7 (SPI0_CE1)	PG8	PI11	PI9
PC2	NC	NC	GPIO 0 (EEPROM_SDA)		GPIO 1 (EEPROM_SCL)	PG7	PI10	PI10
PC4	NC	NC	GPIO 5		GND	GND	GND	GND
PI5	PI9	PG6	GPIO 6		GPIO 12 (PWM0)	PG9	PI12	PI6
PI14	NC	NC	GPIO 13 (PWM1)		GND	GND	GND	GND
PC6	PI1	PC6	GPIO 19 (PCM_FS)		GPIO 16	NC	NC	PG11
PC15	PI13	PC15	GPIO 26		GPIO 20 (PCM_DIN)	PH10	PH10	PH4
GND	GND	GND	GND		GPIO 21 (PCM_DOUT)	PC8	PI2	PC8

ADXL345 Wiring

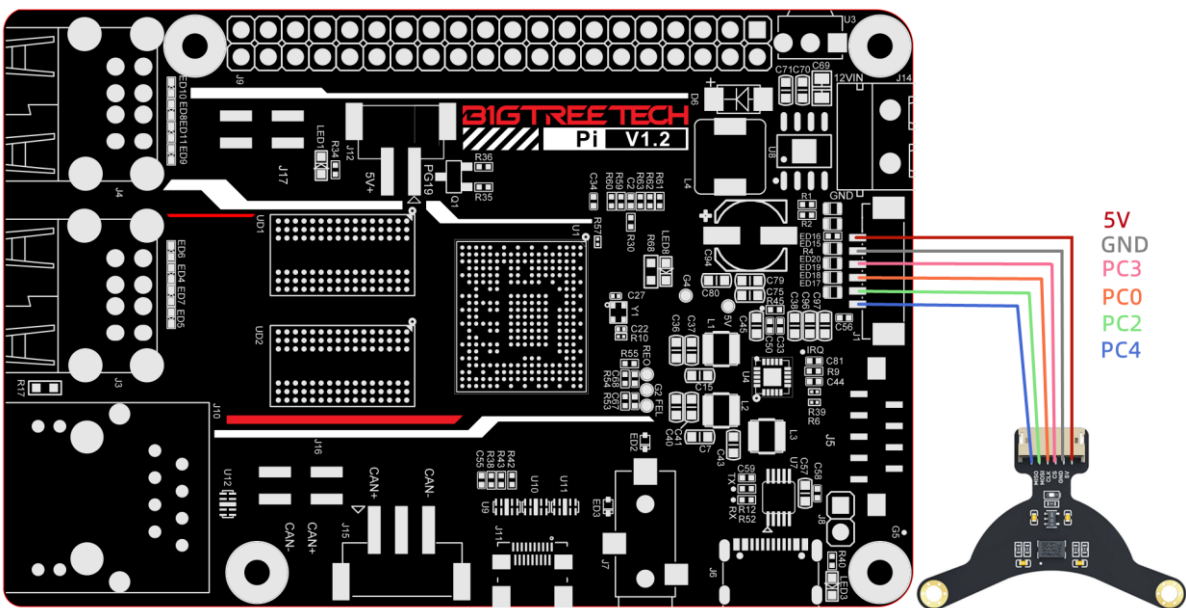

SPI Display Wiring

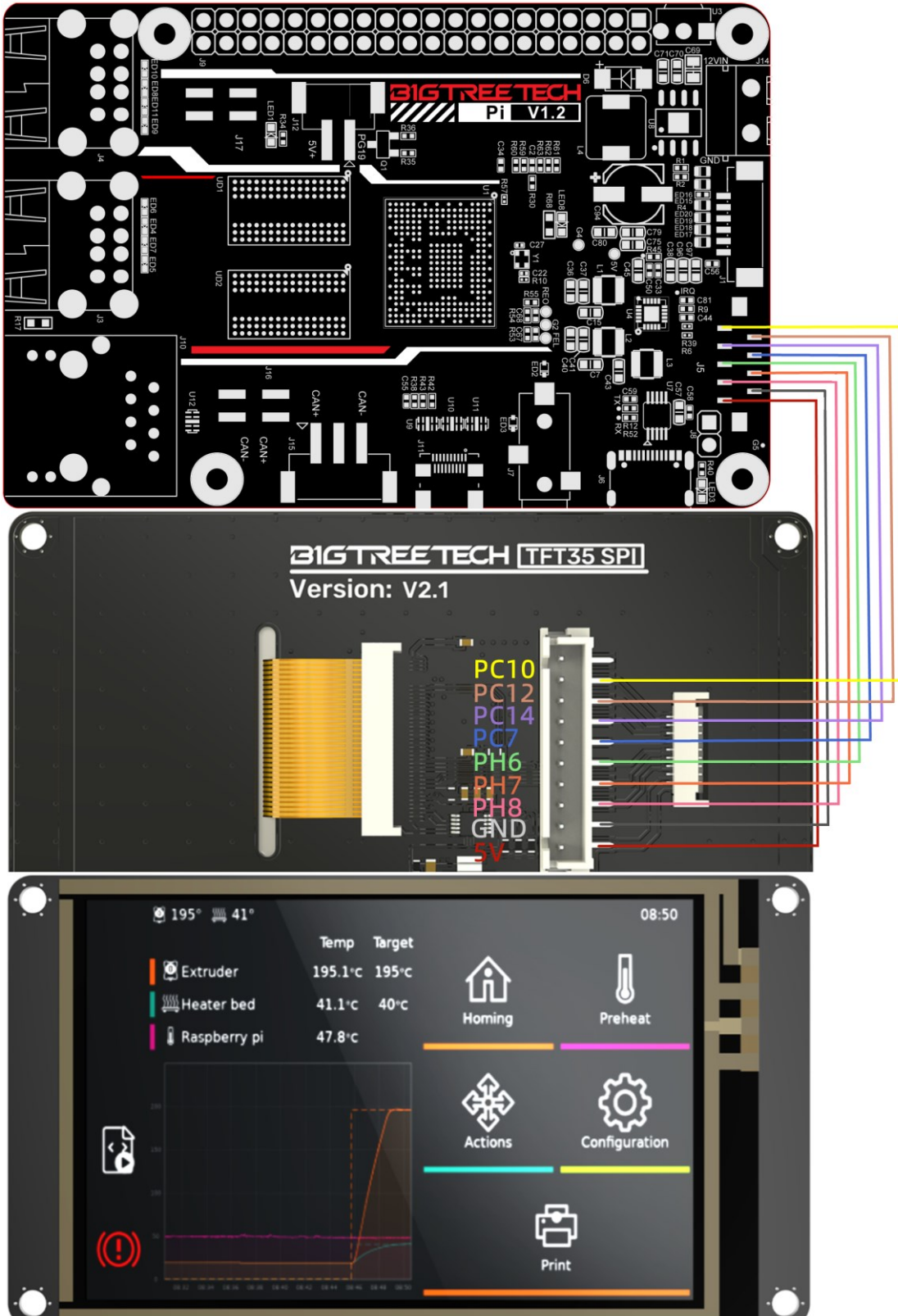

Connecting a USB To CAN Module

Note: when using the U2C module, the SOC's USB2 is used for communication.

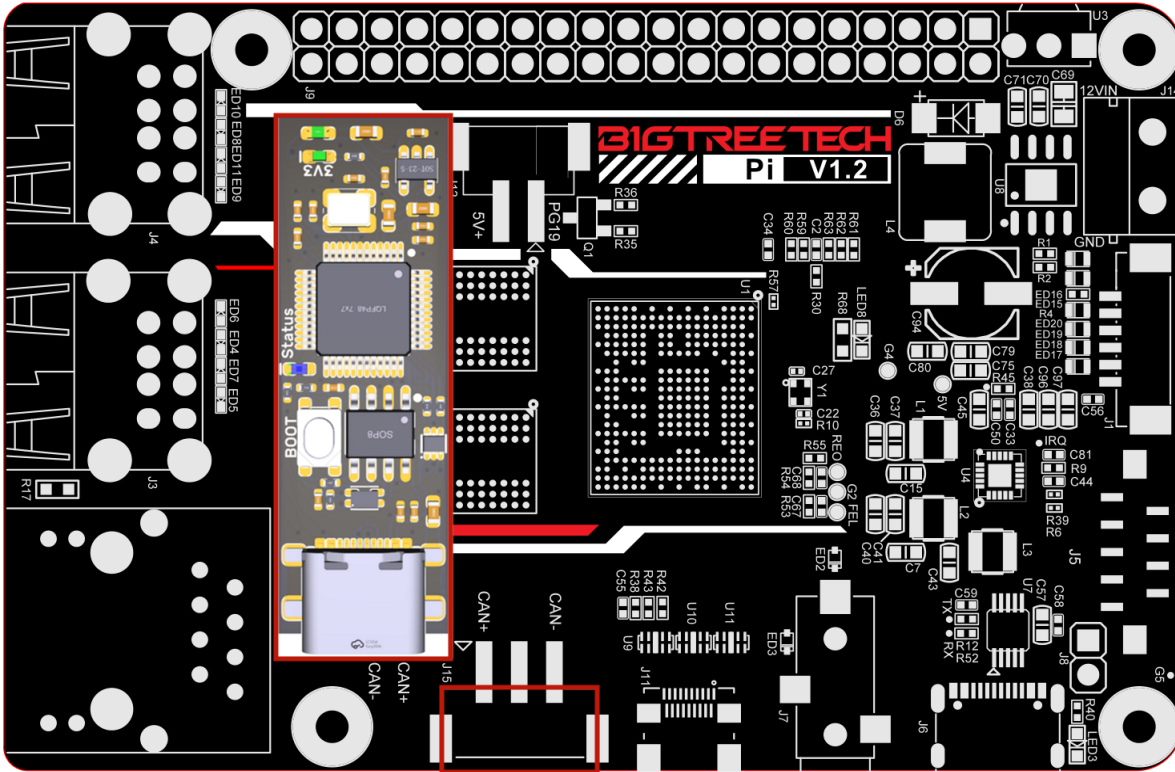

CAN-H GND CAN-L

Fan Wiring

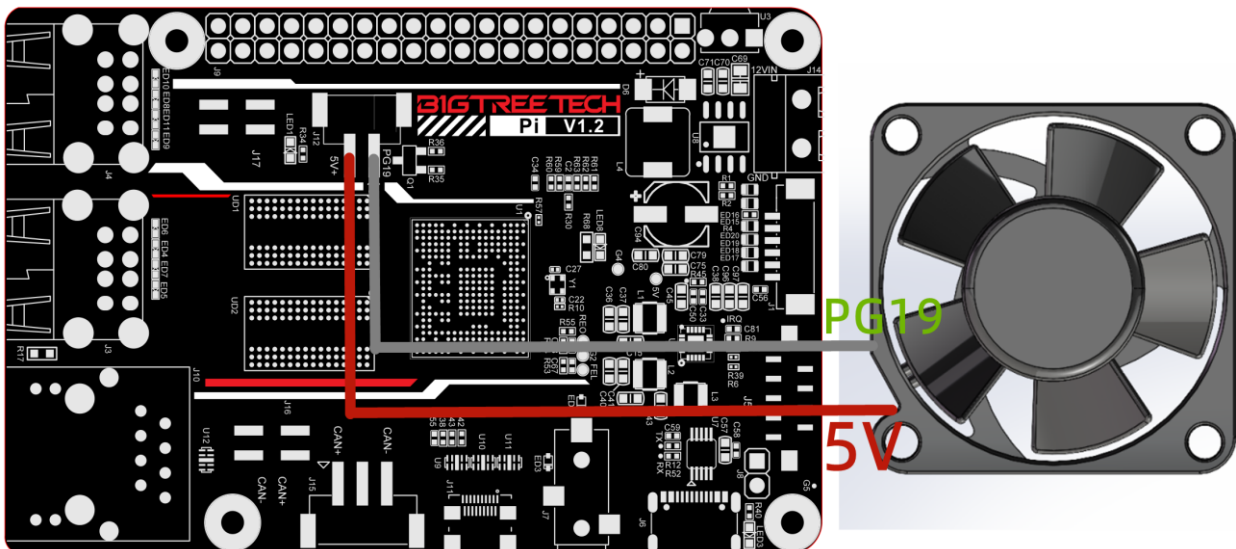

HDMI Display Wiring

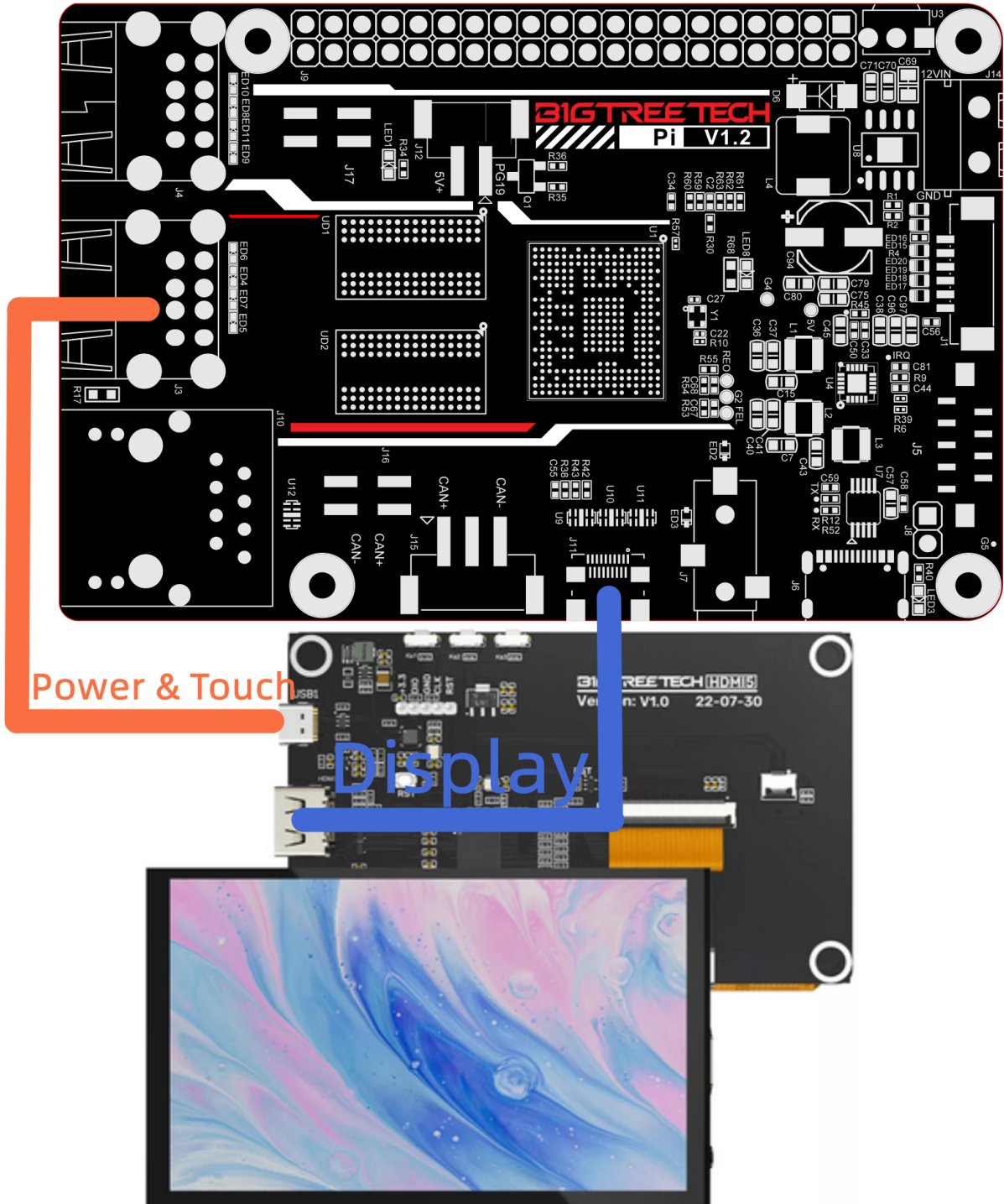

OS Writing

Download OS Image

Please download and install the OS image we provided:

<https://github.com/bigtreotech/CB1/releases>

Download and Install Writing Software

Install the official Raspberry Pi Imager: <https://www.raspberrypi.com/software/>

balenaEtcher: <https://www.balena.io/etcher/>

Choose one of the above software to download and install.

Start to Write OS

Using Raspberry Pi Imager

1. Insert a microSD card into your computer via a card reader.
2. Choose OS.



3. Select "Use custom", then select the image that you downloaded.

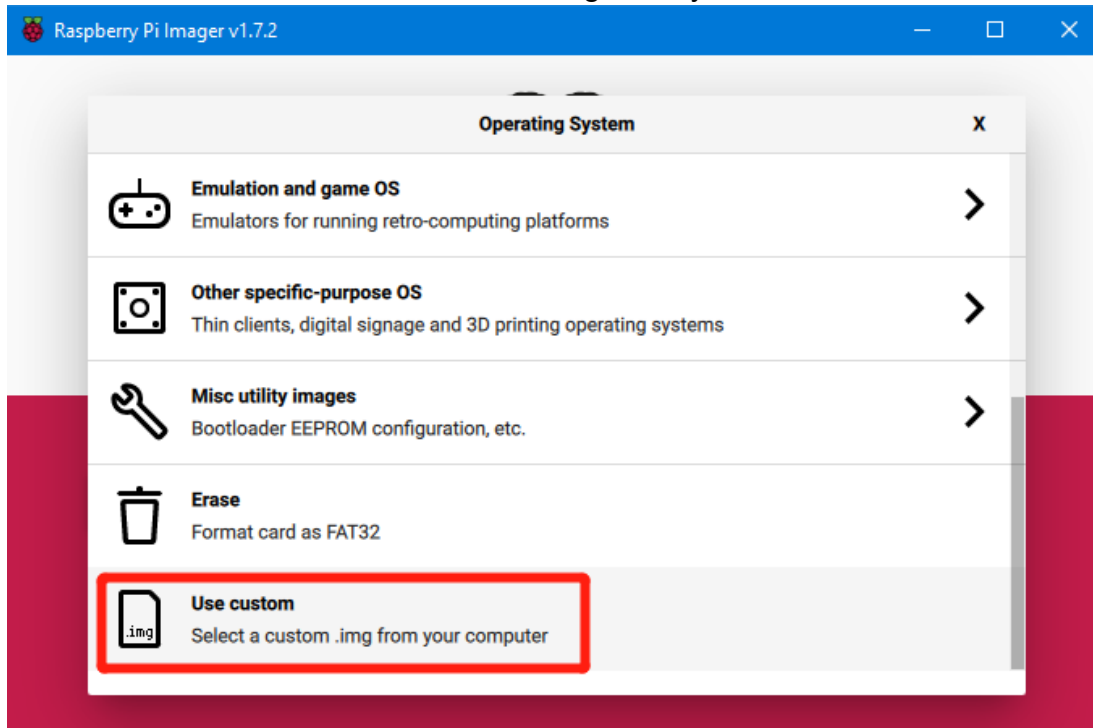

4. Select the microSD card and click "WRITE" (WRITE the image will format the microSD card. Be careful not to select the wrong storage device, otherwise the data will be formatted).



5. Wait for the writing to finish.

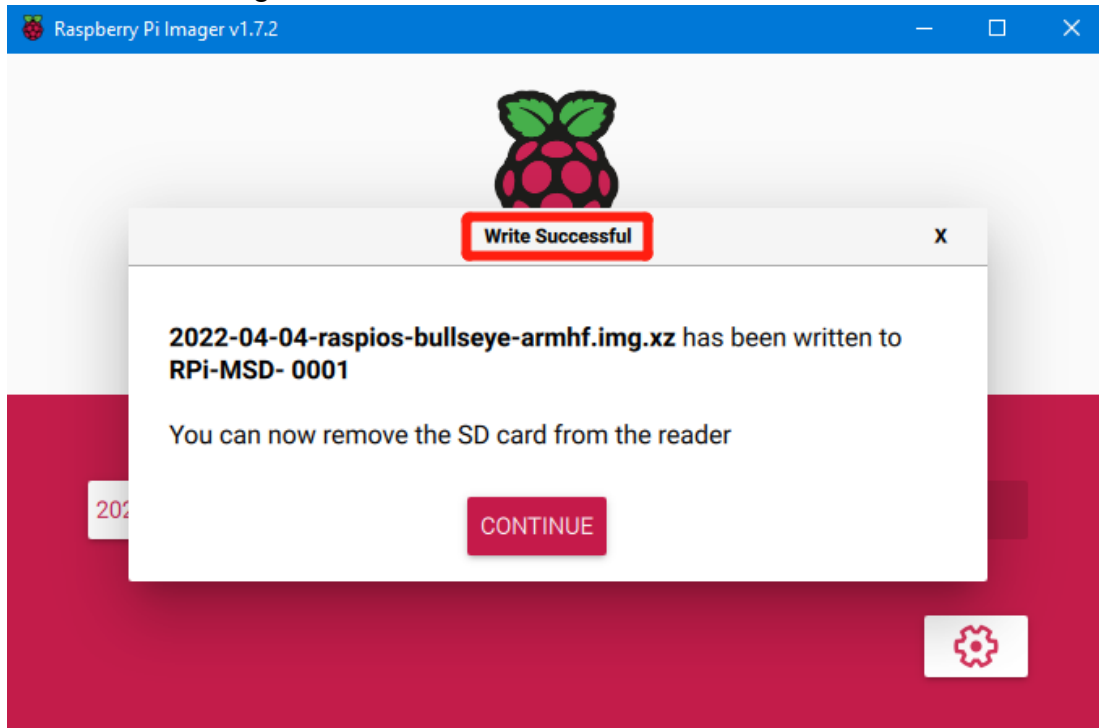

Using balenaEtcher

1. Insert a microSD card into your computer via a card reader.
2. Select the image that you downloaded.

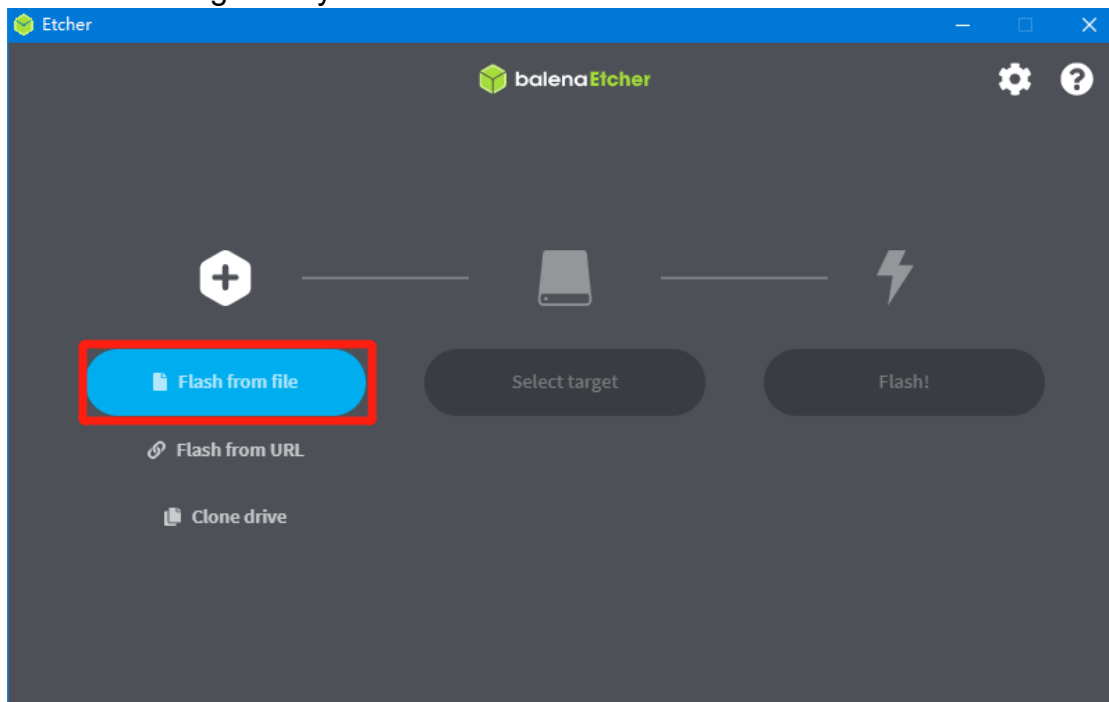

3. Select the microSD card and click "WRITE" (WRITE the image will format the microSD card. Be careful not to select the wrong storage device, otherwise the data will be formatted).

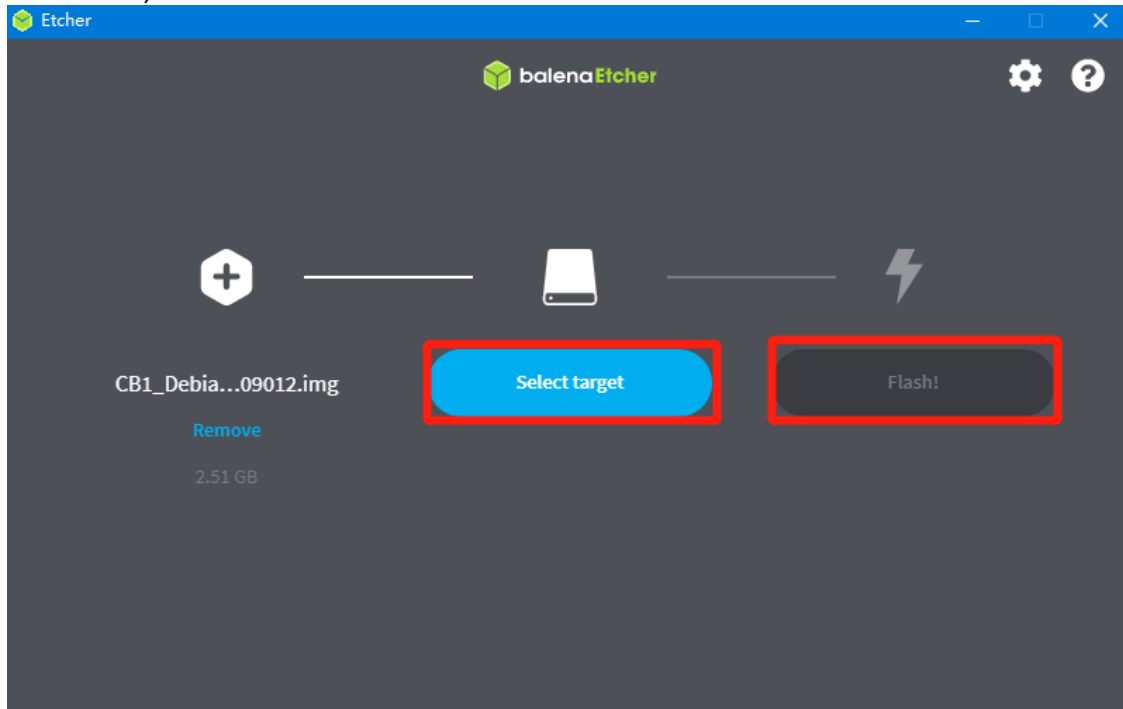

4. Wait for the writing to finish.

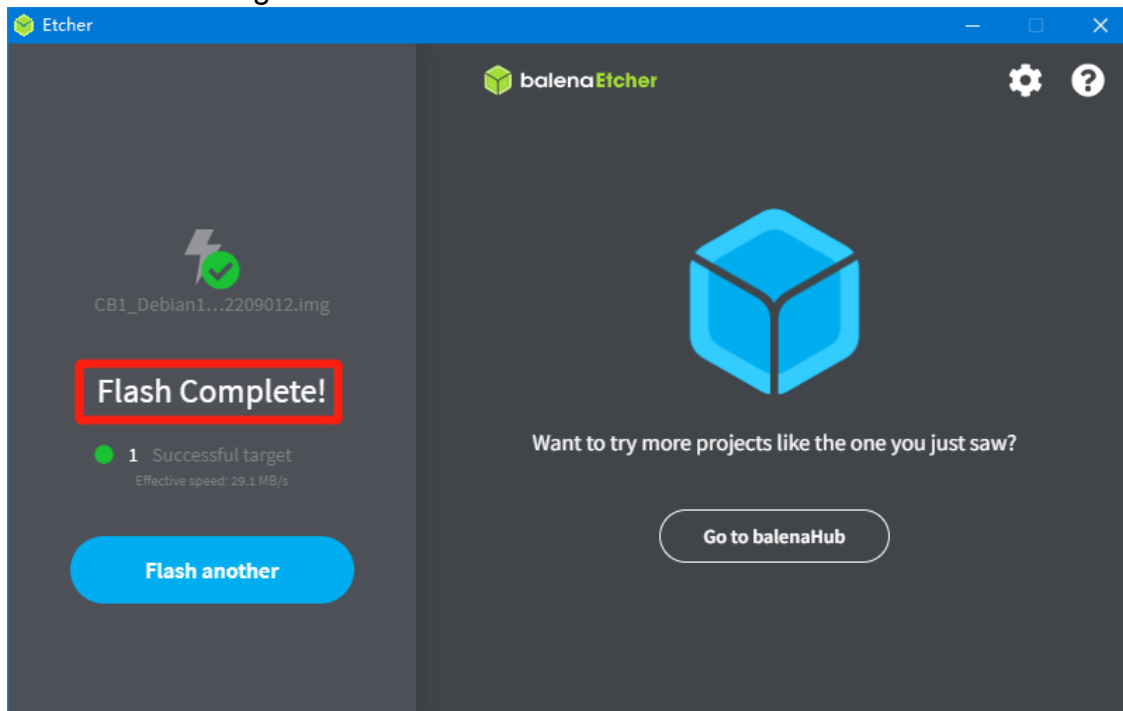

Network Configuration

Wired Network

For wired networks, no additional settings are needed. Just plug and play.

WiFi Setting

After the OS image writing is completed, the microSD card will have a FAT32 recognized by the computer, find "system.cfg".

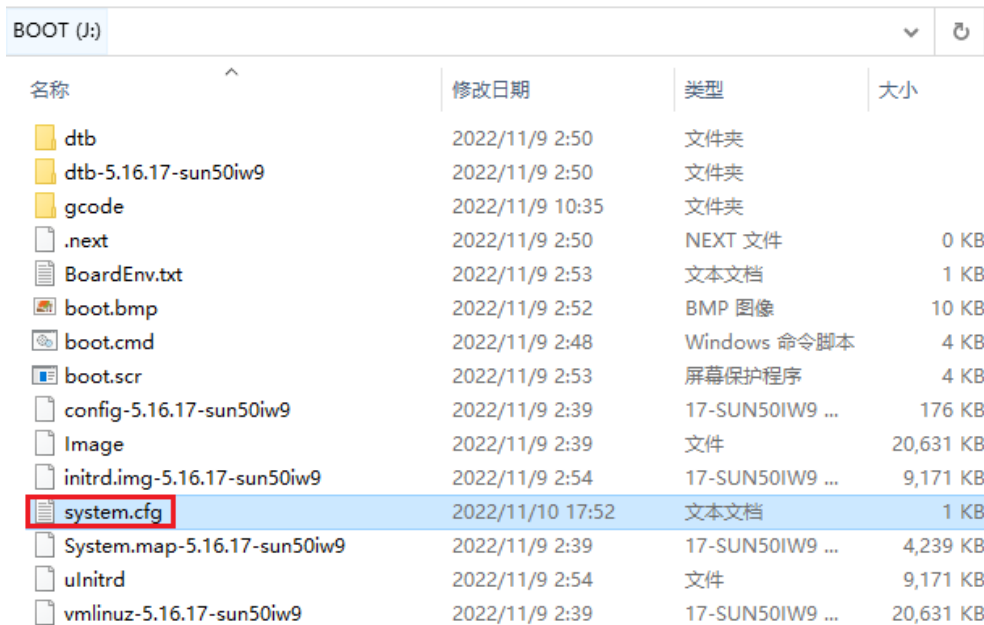

名称	修改日期	类型	大小
dtb	2022/11/9 2:50	文件夹	
dtb-5.16.17-sun50iw9	2022/11/9 2:50	文件夹	
gcode	2022/11/9 10:35	文件夹	
.next	2022/11/9 2:50	NEXT 文件	0 KB
BoardEnv.txt	2022/11/9 2:53	文本文档	1 KB
boot.bmp	2022/11/9 2:52	BMP 图像	10 KB
boot.cmd	2022/11/9 2:48	Windows 命令脚本	4 KB
boot.scr	2022/11/9 2:53	屏幕保护程序	4 KB
config-5.16.17-sun50iw9	2022/11/9 2:39	17-SUN50IW9 ...	176 KB
Image	2022/11/9 2:39	文件	20,631 KB
initrd.img-5.16.17-sun50iw9	2022/11/9 2:54	17-SUN50IW9 ...	9,171 KB
system.cfg	2022/11/10 17:52	文本文档	1 KB
System.map-5.16.17-sun50iw9	2022/11/9 2:39	17-SUN50IW9 ...	4,239 KB
ulnitrd	2022/11/9 2:54	文件	9,171 KB
vmlinuz-5.16.17-sun50iw9	2022/11/9 2:39	17-SUN50IW9 ...	20,631 KB

Open it with Notepad, replace WIFI-SSID with your WiFi name, and PASSWORD with your password.

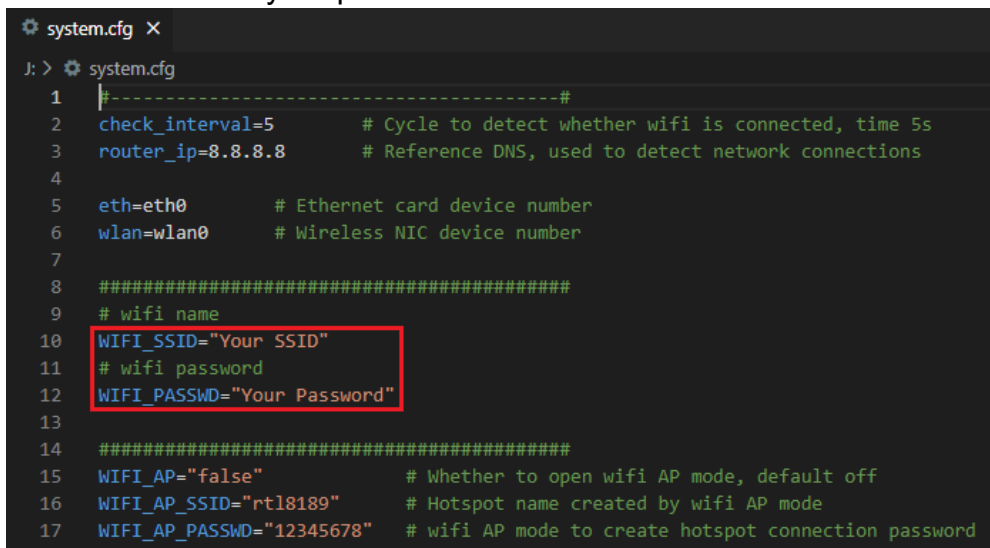

```
system.cfg X
J: > system.cfg
1 | #-----#
2 | check_interval=5      # Cycle to detect whether wifi is connected, time 5s
3 | router_ip=8.8.8.8    # Reference DNS, used to detect network connections
4 |
5 | eth=eth0             # Ethernet card device number
6 | wlan=wlan0          # Wireless NIC device number
7 |
8 | #####
9 | # wifi name
10 | WIFI_SSID="Your SSID"
11 | # wifi password
12 | WIFI_PASSWD="Your Password"
13 |
14 | #####
15 | WIFI_AP="false"     # Whether to open wifi AP mode, default off
16 | WIFI_AP_SSID="rtl8189" # Hotspot name created by wifi AP mode
17 | WIFI_AP_PASSWD="12345678" # wifi AP mode to create hotspot connection password
```



Configure the Motherboard

SSH Connect to Device

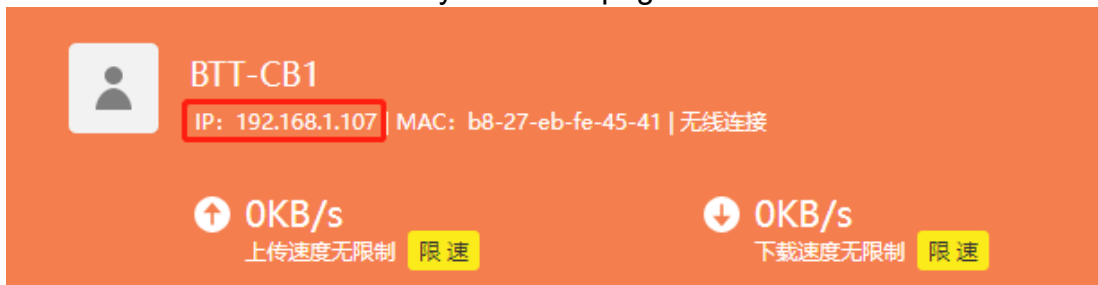
1. Install the SSH application MobaXterm: <https://mobaxterm.mobatek.net/download-home-edition.html>
2. Insert the microSD card into the motherboard, and wait for the system to load after powering on, approx. 1-2min.
3. The device will automatically be assigned an IP address after successfully connecting to the network.
4. Find the device IP address on your router page.

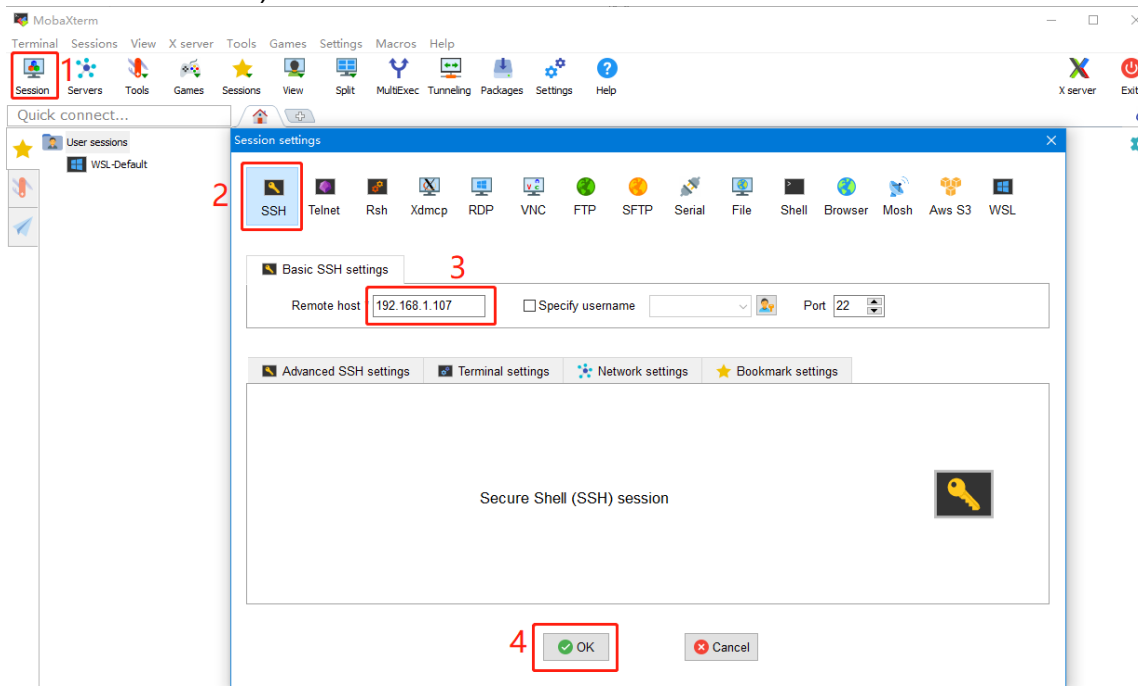

5. Open MobaXterm and click "Session", and click "SSH", enter the device IP into the Remote host, and click "OK" (Note: your computer and the device needs to be under the same network).



6. Login

Login as: biqu

Password: biqu

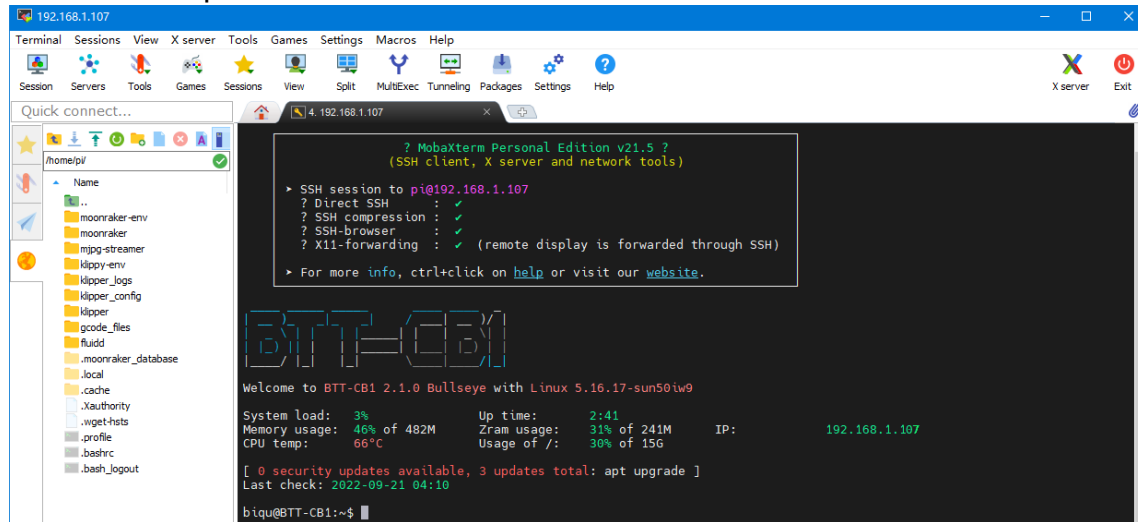

Compile MCU Firmware

1. After SSH is successfully connected to the device, enter in the terminal:

```
cd ~/klipper/
```

```
make menuconfig
```

The firmware is compiled based on the motherboard configuration, here we take Manta M4P as an example:

- * **[*] Enable extra low-level configuration options**
- * **Micro-controller Architecture (STMicroelectronics STM32) --->**
- * **Processor model (STM32G0B1) --->**
- * **Bootloader offset (8KiB bootloader) --->**
- * **Clock Reference (8 MHz crystal) --->**
- * **Communication interface (USB (on PA11/PA12)) --->**

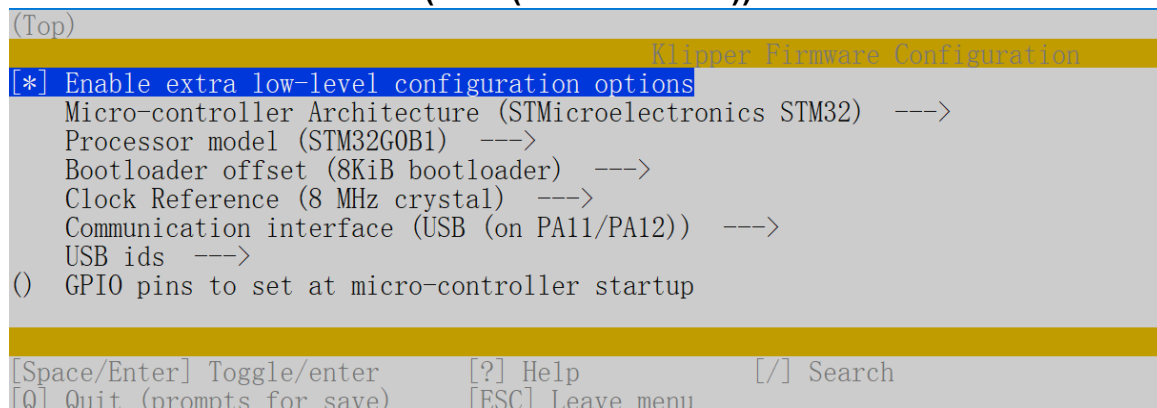

深圳市必趣科技有限公司
BIGTREETECH

2. Press 'q' to exit, and "Yes" when asked to save the configuration.
3. Run **make** to compile firmware, 'klipper.bin' file will be generated in the **home/pi/klipper/out** folder when **make** is finished, download it onto your computer using the SSH application.

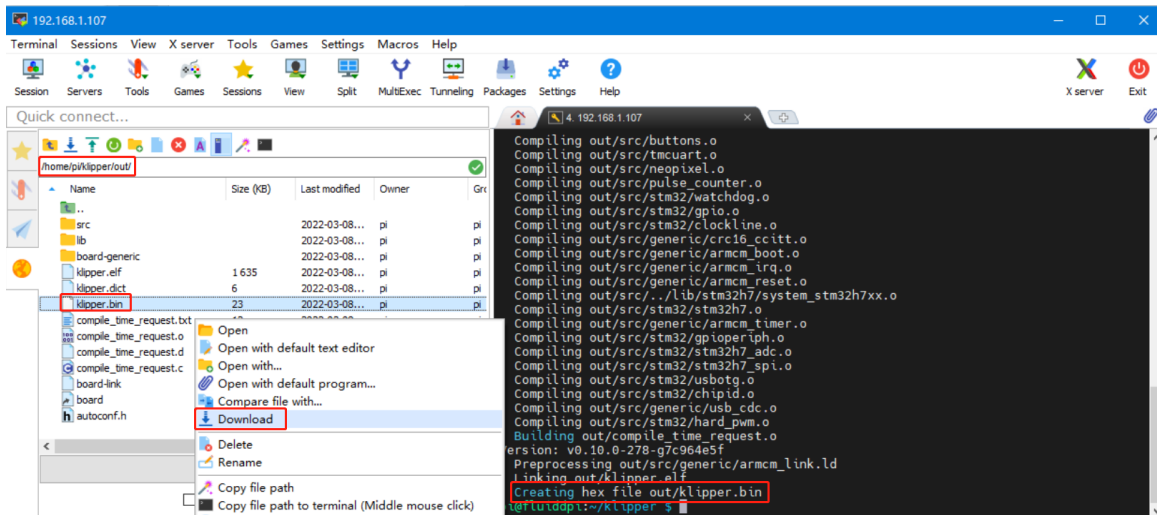

Cautions

Pay attention to the heat dissipation of Pi. If the running application consumes too many system resources, it will get hot quite serious.

If you need other resources for this product, please visit <https://github.com/bigtreotech/> and find them yourself. If you cannot find the resources you need, you can contact our after-sales support.

If you encounter other problems during use, feel free to contact us, and we are answering them carefully; any good opinions or suggestions on our products are welcome, too and we will consider them carefully. Thank you for choosing BIGTREETECH. Your support means a lot to us!